

## Formal Basis

The current EN 14509 covers self-supporting structural sandwich panels. **Point and line loads** extends the application area **outside the scope of EN 14509**.

Therefore the extended application shall be **regulated nationally**

A new ECCS/CIB-document (N61) intends to provide guidance on design, detailing and application of sandwichpanels with point or line loads

## General Remark

Line- and point-loads occur on sandwich panels due to additional use for the load transfer, e.g. because of installation of solar photovoltaic- or solar collector-systems on the roof or of attached facades on the wall. This results in additional loads which shall be taken into account as point- or line-loads in the design of sandwich panels.

## ECCS TWG 7.9 / CIB W56 12./13.06.2014 Istanbul Panels with Point or Line Loads



# ECCS TWG 7.9 / CIB W56 12./13.06.2014 Istanbul Panels with Point or Line Loads



# ECCS TWG 7.9 / CIB W56 12./13.06.2014 Istanbul

## Panels with Point or Line Loads



**ECCS TWG 7.9 / CIB W56 12./13.06.2014 Istanbul**  
**Panels with Point or Line Loads**

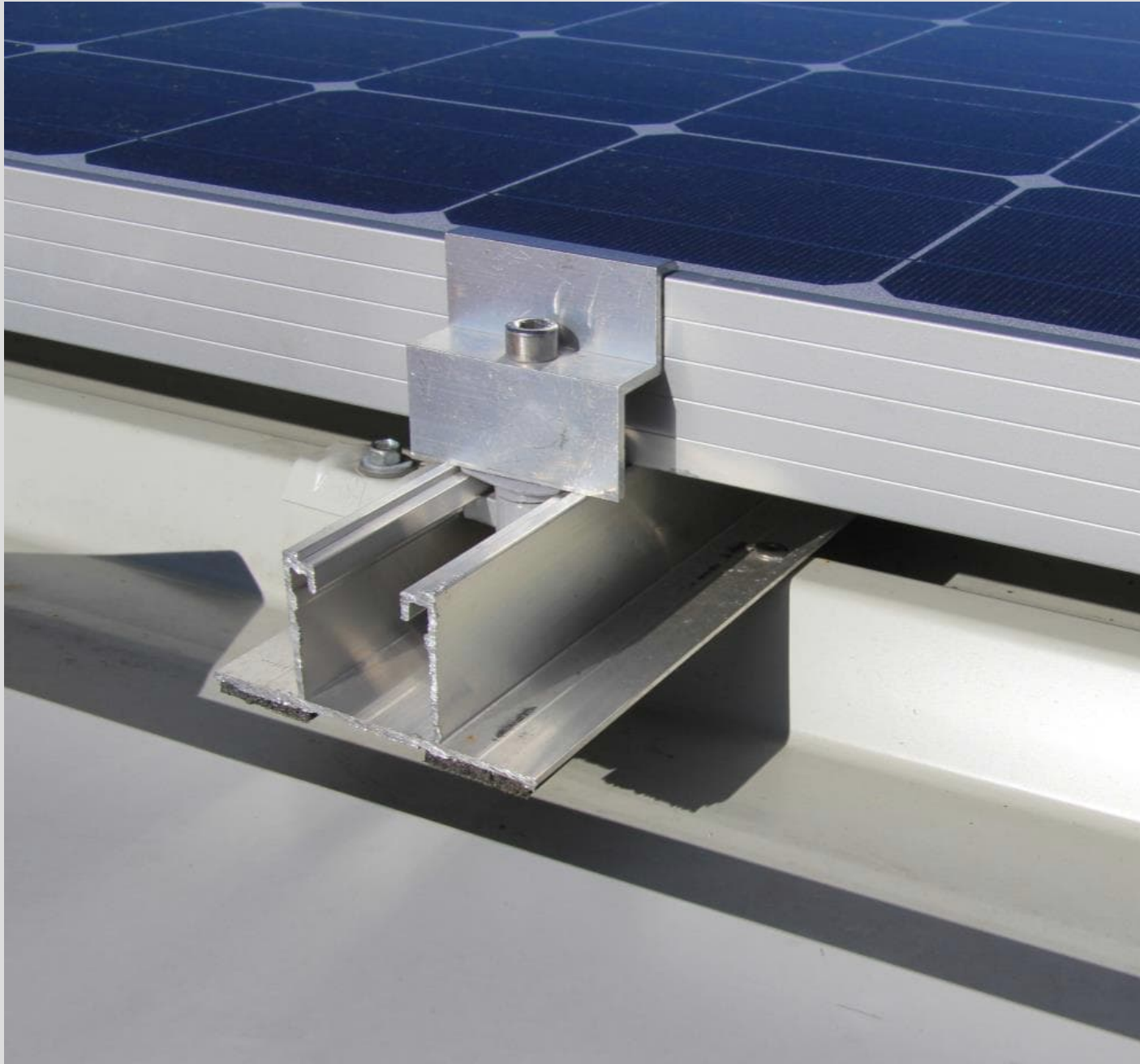

# ECCS TWG 7.9 / CIB W56 12./13.06.2014 Istanbul

## Panels with Point or Line Loads

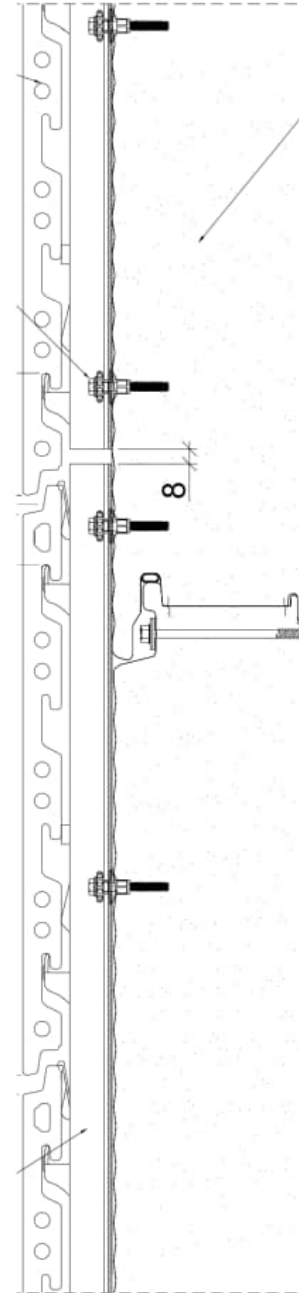

# ECCS TWG 7.9 / CIB W56 12./13.06.2014 Istanbul

## Panels with Point or Line Loads

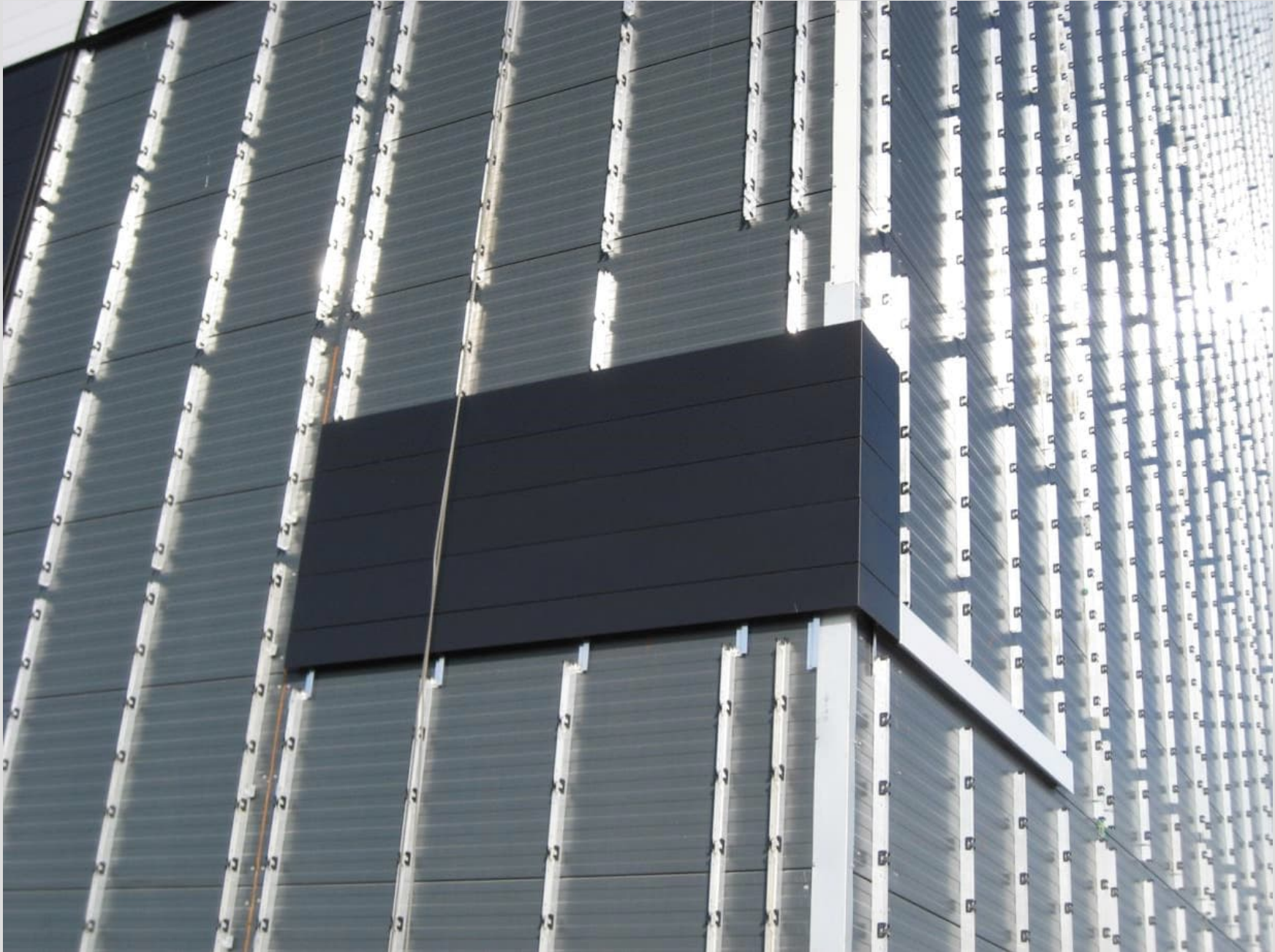



# ECCS TWG 7.9 / CIB W56 12./13.06.2014 Istanbul Panels with Point or Line Loads



# ECCS TWG 7.9 / CIB W56 12./13.06.2014 Istanbul

## Panels with Point or Line Loads

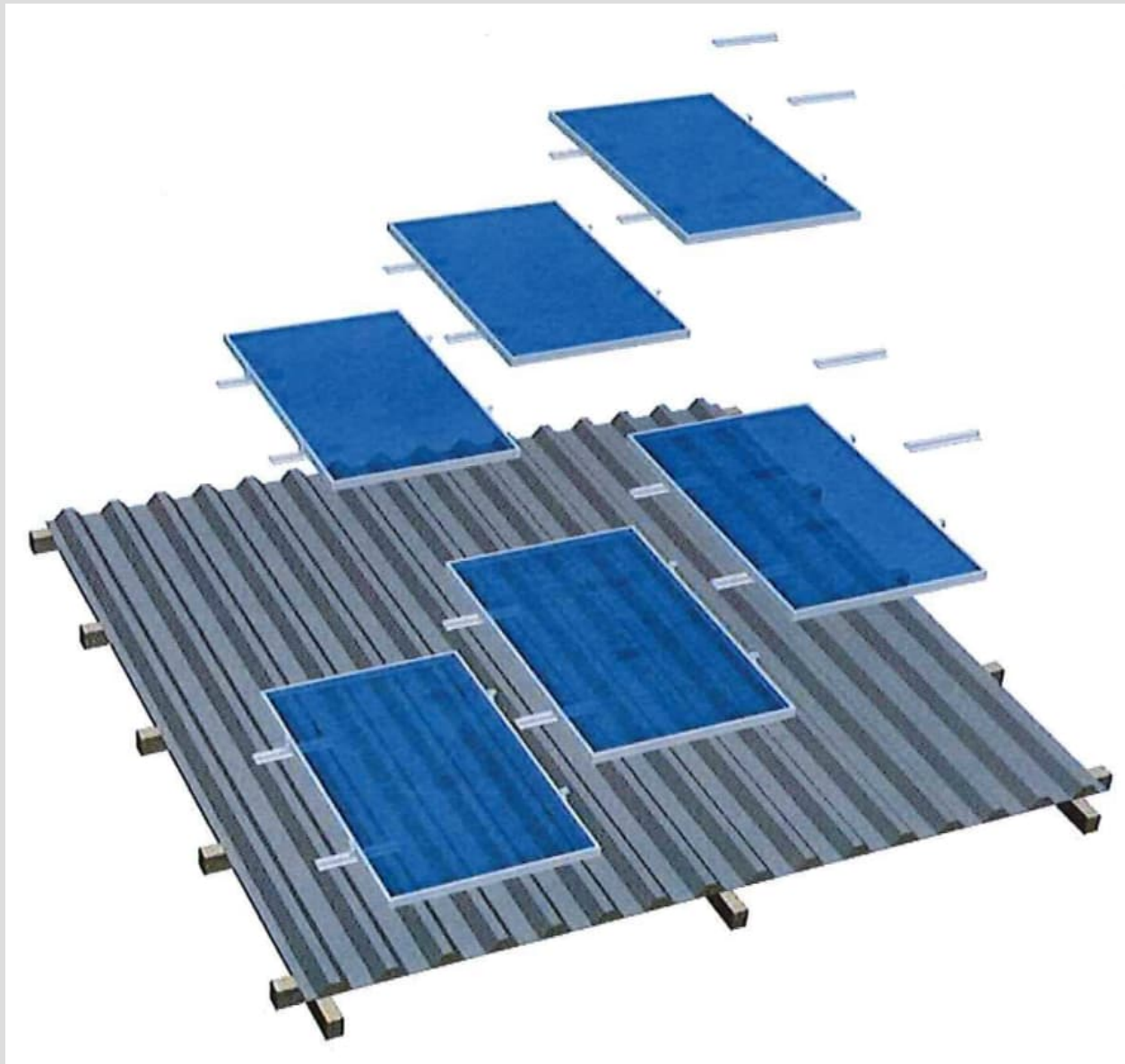

# ECCS TWG 7.9 / CIB W56 12./13.06.2014 Istanbul

## Panels with Point or Line Loads

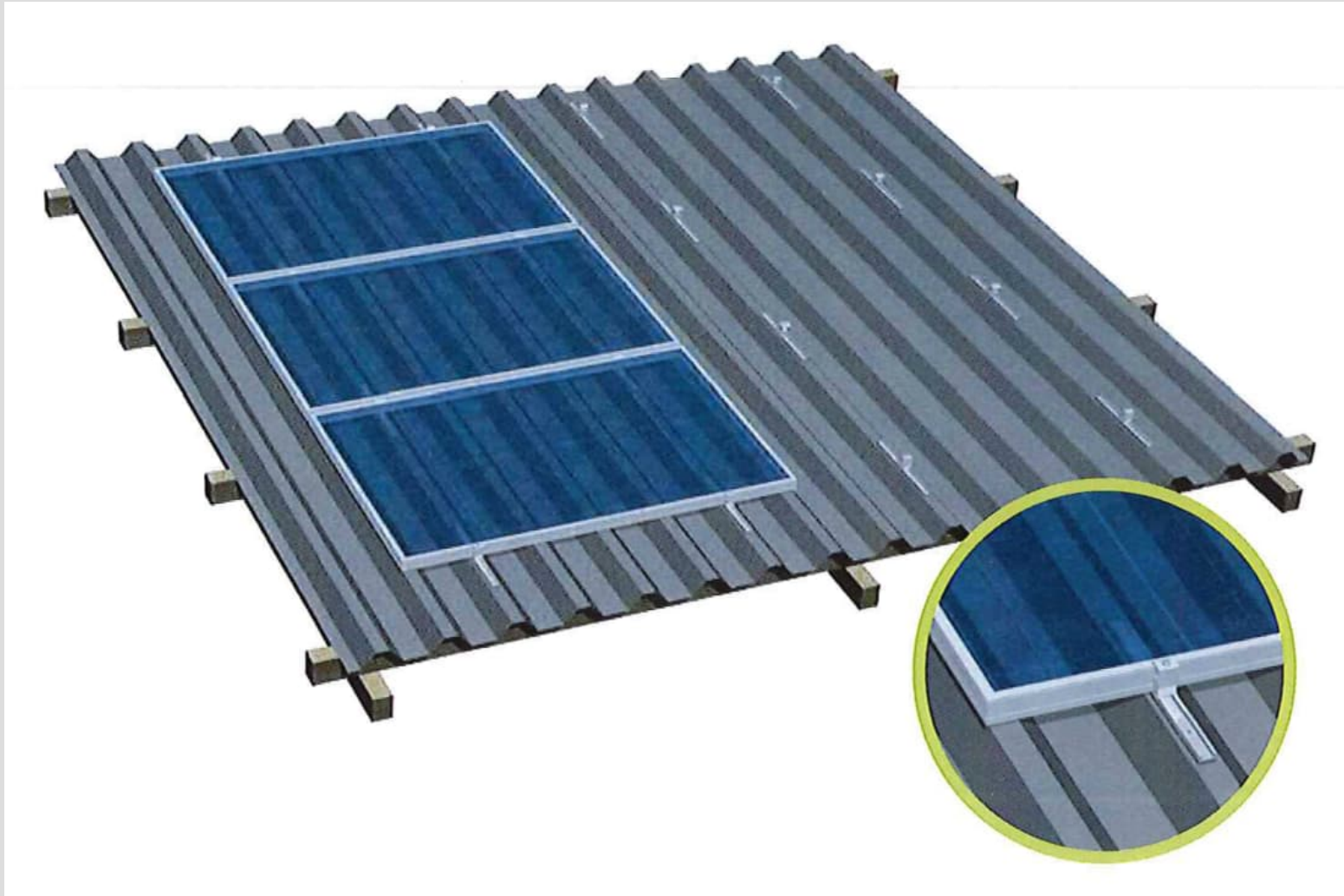

# ECCS TWG 7.9 / CIB W56 12./13.06.2014 Istanbul

## Panels with Point or Line Loads

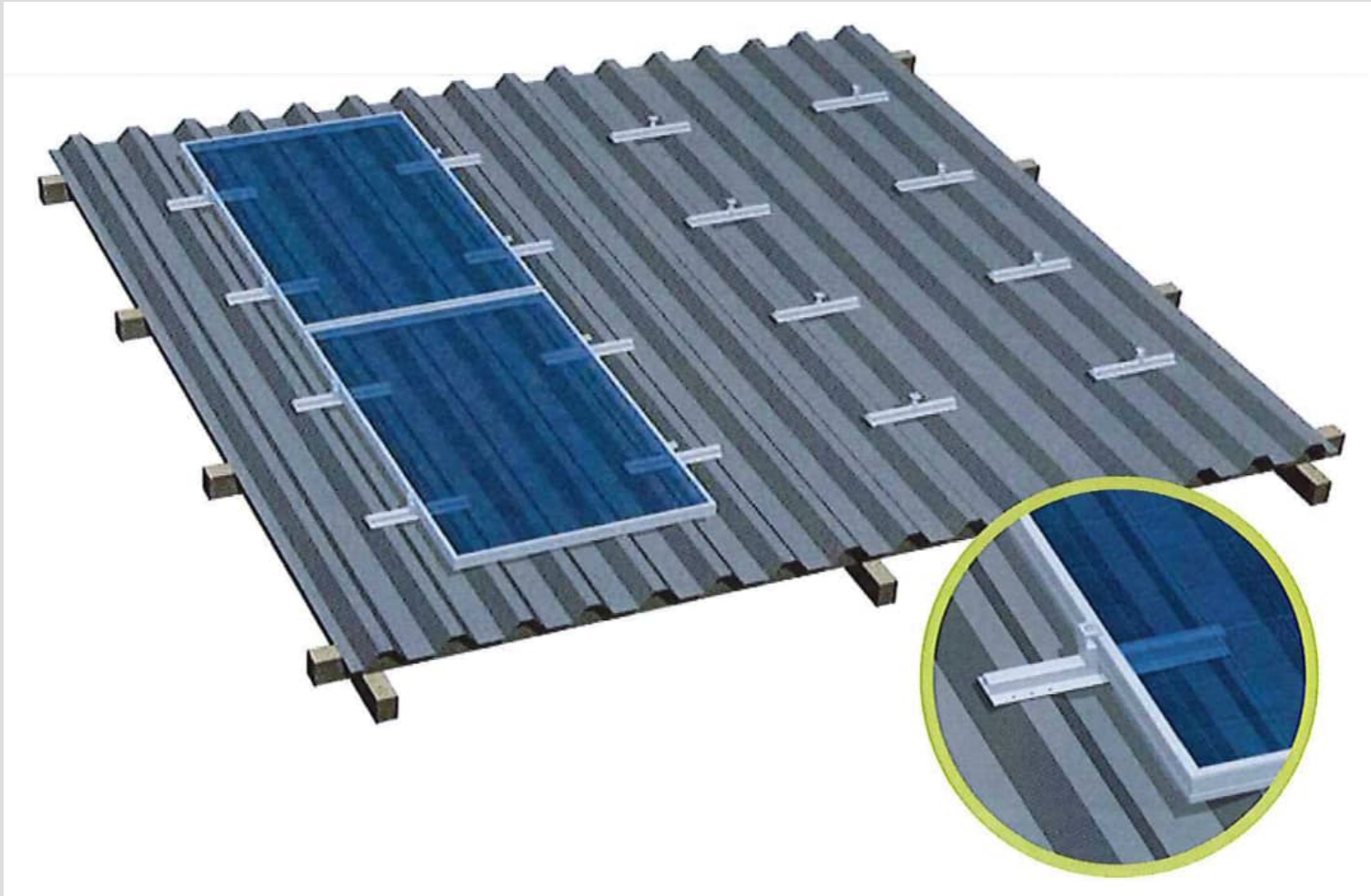

# ECCS TWG 7.9 / CIB W56 12./13.06.2014 Istanbul

## Panels with Point or Line Loads

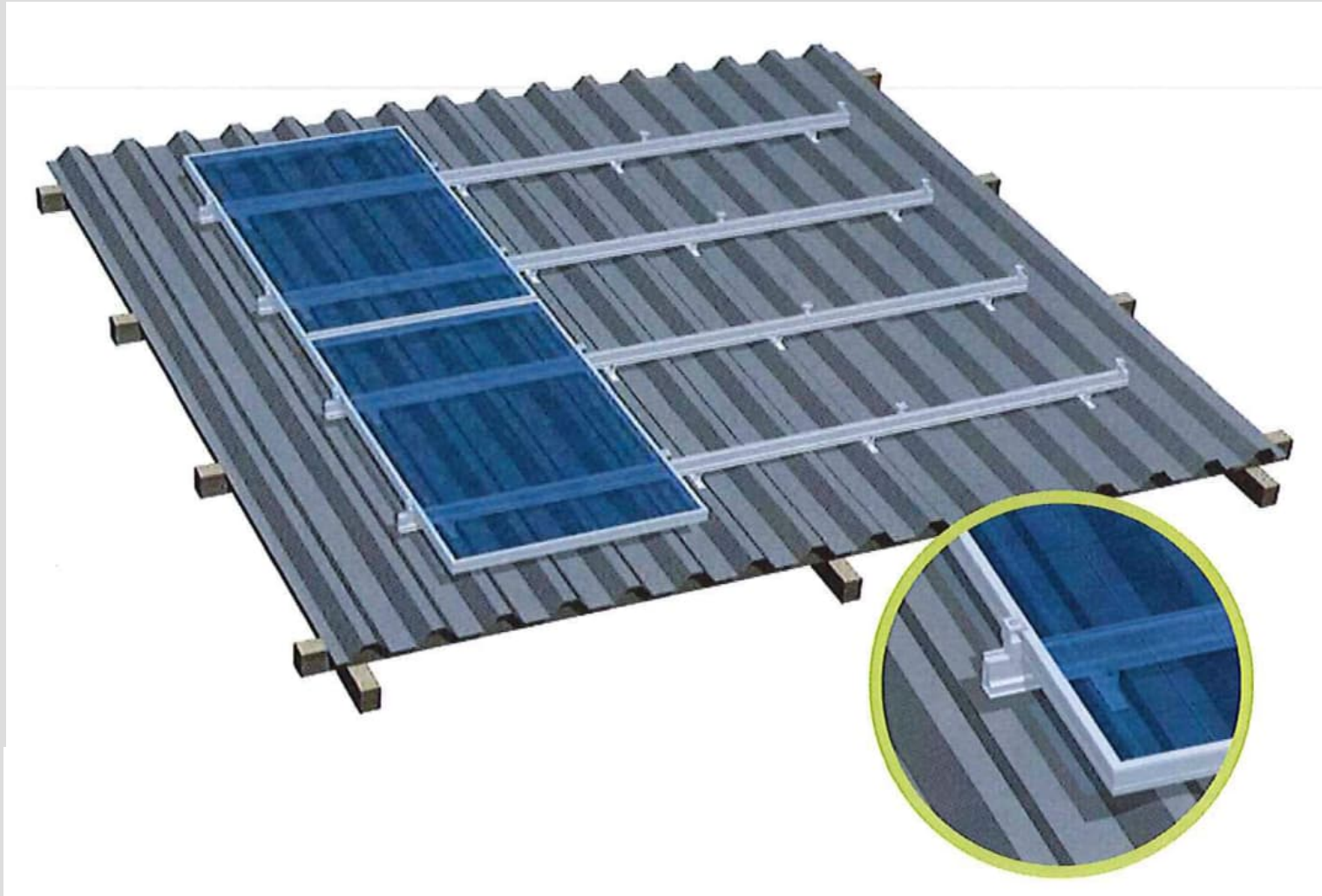

Prior information notice

## Special Solar Fasteners

In practice, also **special solar fasteners** are used for the **transfer of loads** e.g. of solar photovoltaic-systems on the roof **directly to the substructure**. By load distribution beams, the loads are always introduced only into the special fasteners, which are directly fixed through the Sandwich panels on the substructure, e.g. the purlins.

This is not subject of the following statements about point and line loads.

# ECCS TWG 7.9 / CIB W56 12./13.06.2014 Istanbul

## Panels with Point or Line Loads

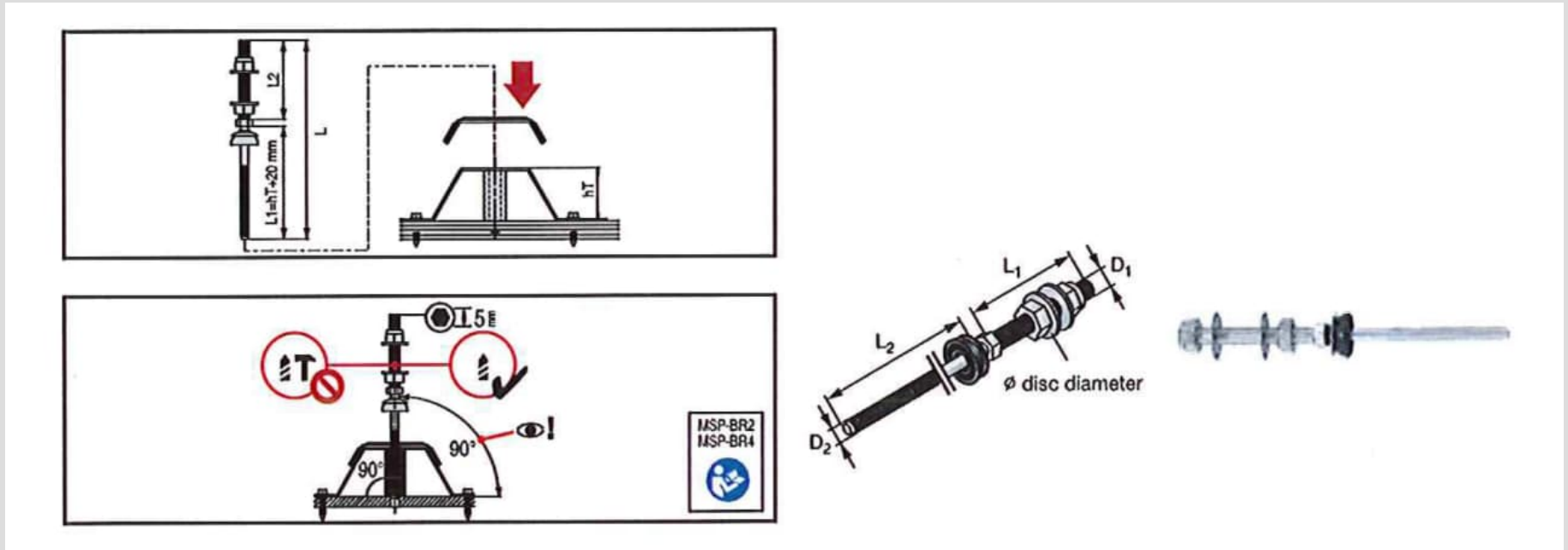

### 3 SYSTEMATIC

#### 3.1 Line loads , vertical loads downwards (pressing)

##### 3.1.1 Line loads transversely to the direction of the span

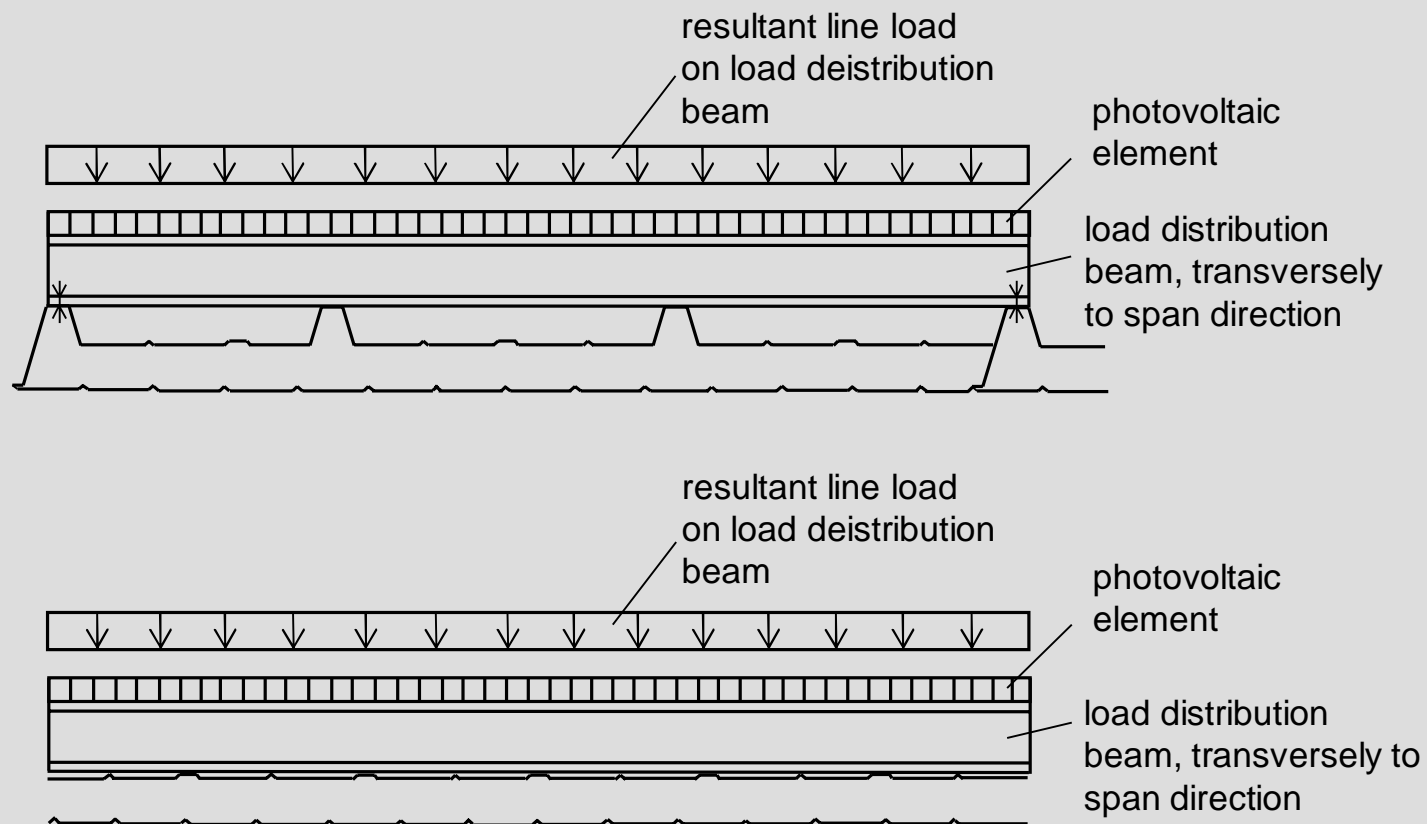



### 3 SYSTEMATIC

3.1 Line loads , vertical loads downwards (pressing)

3.1.2 Line loads parallel to the span direction

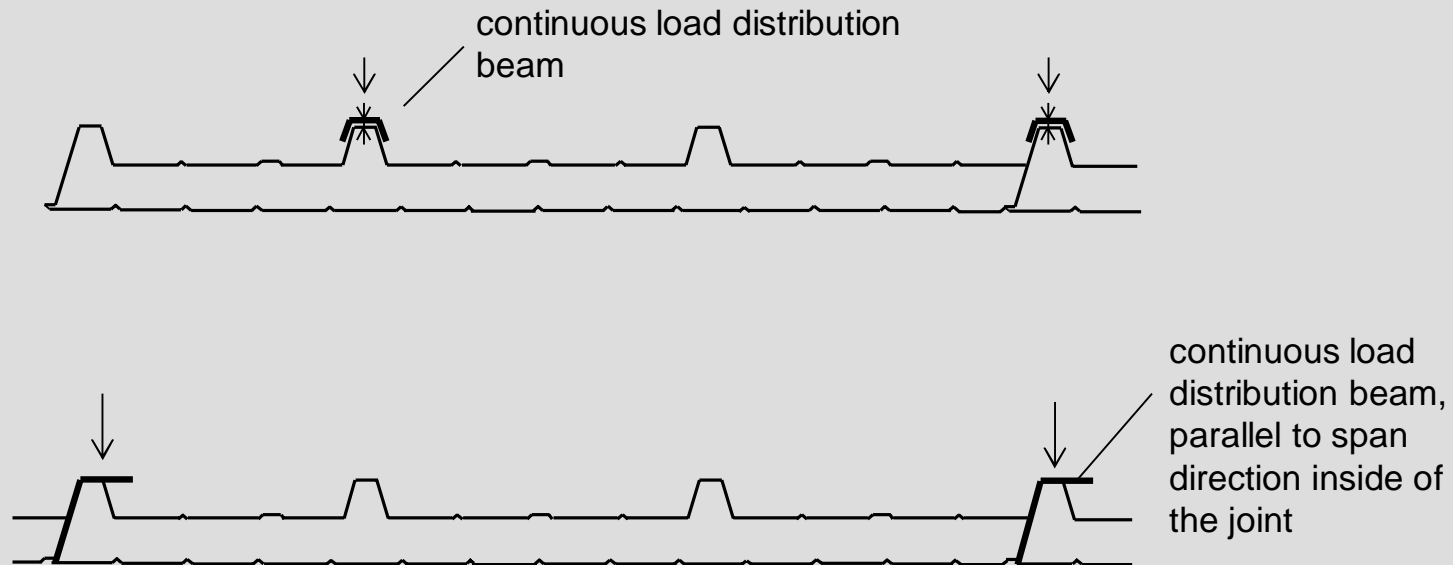

# ECCS TWG 7.9 / CIB W56 12./13.06.2014 Istanbul

## Panels with Point or Line Loads

Allgemeine bauaufsichtliche Zulassung  
Nr. Z-10.4-540 vom 22. Mai 2012



### Befestigung der Montageschiene auf dem Dachelement „FischerTHERM D“

Festpunkt:

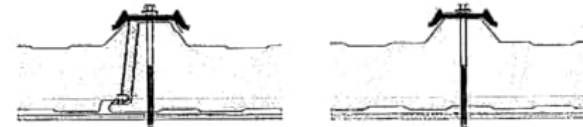

Je Montageschiene eine Schraube nach allgemeiner bauaufsichtlicher Zulassung Nr. Z-14-4-407

Langlöcher:



Je Langloch mittig ein Presslaschenblindniet ALU 5,2 x 22,5 mit Scheiben Ø 16 mm gemäß allgemeiner bauaufsichtlicher Zulassung Nr. Z-14.1-4

### Montageschiene mit Anbauteilen

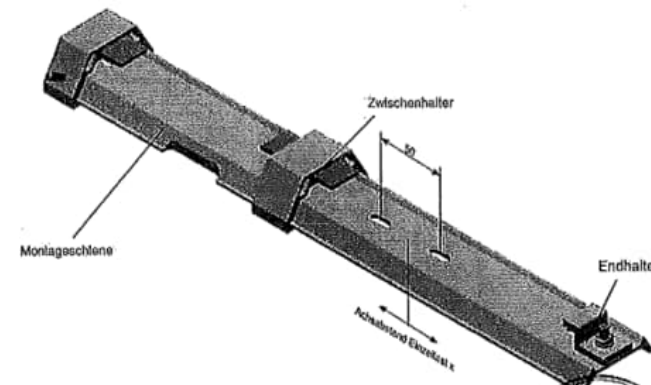

Tragende Sandwichelemente \*FischerTHERM\* und \*FischerFIREPROOF\*  
Wand- und Dachelemente

Verbindungen,  
Befestigung der Montageschiene auf dem Dachelement „FischerTHERM D“

Anlage B, Blatt 5.03

# ECCS TWG 7.9 / CIB W56 12./13.06.2014 Istanbul

## Panels with Point or Line Loads

### 3 SYSTEMATIC

#### 3.2 Point-loads

#### 3.2.1 Point-loads, vertical loads, downward (pressing)

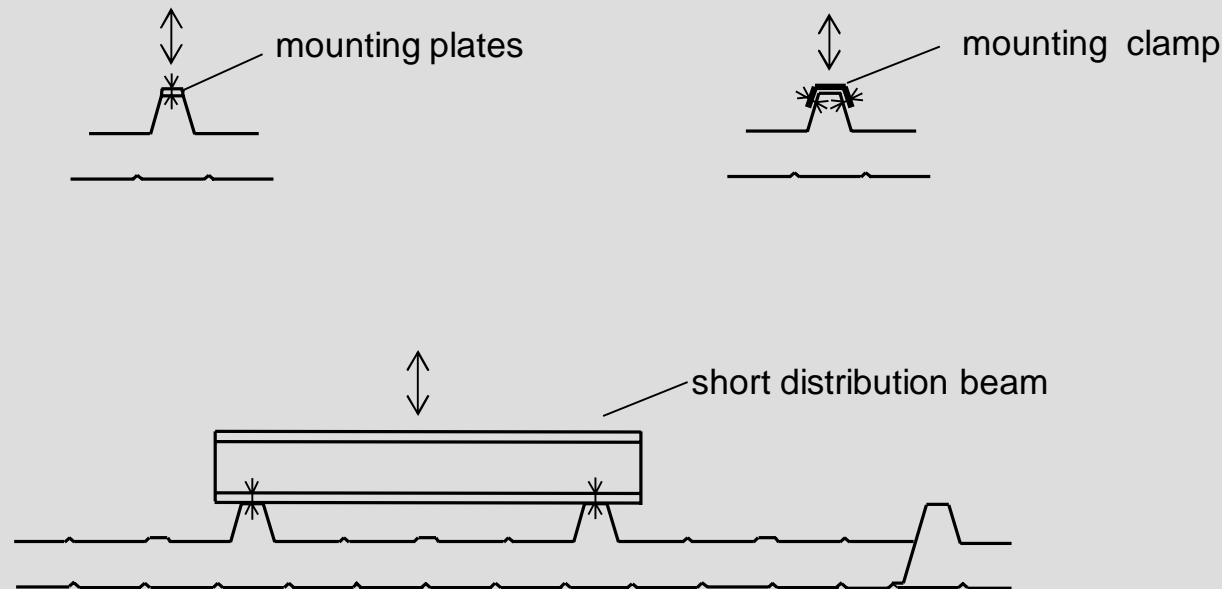

# ECCS TWG 7.9 / CIB W56 12./13.06.2014 Istanbul

## Panels with Point or Line Loads

Allgemeine bauaufsichtliche Zulassung  
Nr. Z-10.4-583 vom 16. April 2014

Deutsches  
Institut  
für  
Bautechnik **DIBt**

### Befestigung der Trapezschelle "Fix 2000 KlickTop"

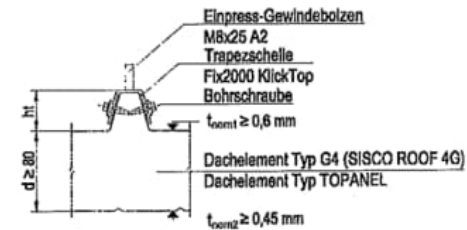

### Trapezschelle "Fix 2000 KlickTop"

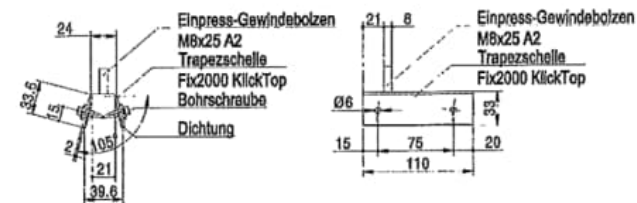
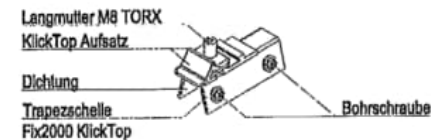

Trapezschelle "Fix 2000 KlickTop": Nach allgemeiner bauaufsichtlicher Zulassung Nr. Z-14.4-646  
Der KlickTop Aufsatz ist entsprechend der Darstellung in Richtung der Schellenlängsachse anzuordnen (nicht verdreht).

Befestigung der Trapezschelle: Je Schelle 4 Bohrschrauben "EJOT JF3-2-5,5x25" nach allgemeiner bauaufsichtlicher Zulassung Nr. Z-14.4-426

Tragende Sandwichelemente "System Metecno" mit Stahldeckschichten und einem Kernwerkstoff aus Polyurethan-Hartschaum;

Befestigung der Trapezschelle "Fix 2000 KlickTop" an den Stegen der trapezprofilierten oberen Deckschicht der Sandwich-Dachelemente

Anlage 5.4

# ECCS TWG 7.9 / CIB W56 12./13.06.2014 Istanbul

## Panels with Point or Line Loads

Allgemeine bauaufsichtliche Zulassung  
Nr. Z-10.4-583 vom 16. April 2014

Deutsches  
Institut  
für  
Bautechnik **DIBt**

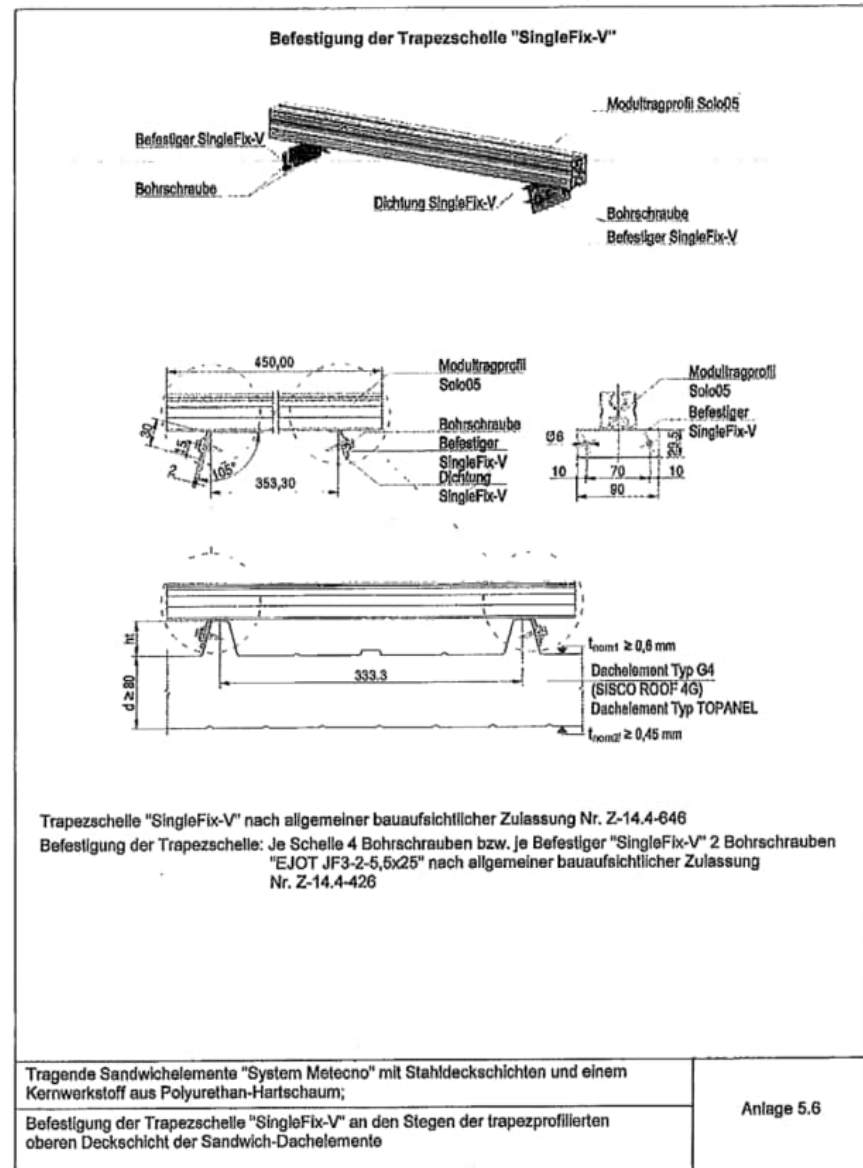

### 3 SYSTEMATIC

#### 3.2 Point-loads

#### 3.2.2 Point-loads, vertical loads, upward (uplifting)

Here particularly must be checked the "pulling out" of the fixing from the outer face and a possible local damage due of the fixing in the face regarding the remaining load bearing capacity of the panels.

## 4 LINE LOADS

4.1 Line loads transversely to the direction of the span, vertical loads, downward (pressing)

### 4.1.1 Special characteristics

If panels are loaded by a **uniformly distributed line load transversely over the whole width** of the panel (e.g. with load distribution beams), the load bearing behavior can be checked easily with the common Sandwich theory. This applies especially for panels with flat or lightly profiled faces. For panels with profiled faces, this can be done only if the distance of trapezoidal profiles is less than the loadbearing width per rib.

Additionally the local compressive stresses in the panels have to be checked.

## 4 LINE LOADS

4.1 Line loads transversely to the direction of the span, vertical loads, downward (pressing)

### 4.1.2 Tests

If tests are required to define the load bearing width, these should be carried out analogous to chapter 5.1.2



## 4 LINE LOADS

4.1 Line loads transversely to the direction of the span, vertical loads, downward (pressing)

### 4.1.3 Design

The base for calculation of the stresses and the design procedures is chapter E of EN 14509.

For the design regarding the ultimate and serviceability limit state the stresses from the point loads shall be combined for a practical design with all other relevant stresses according to chapter E, EN 14509.



$F$  = design load =  $q_L/b$   
 $q_L$  = line load  
 $b$  = panel width  
 $x$  = distance to the support

## 4 LINE LOADS

4.2 Line loads parallel to the direction of the span, vertical loads, downward (pressing)

### 4.1.3 Special characteristics

If panels are loaded by line loads parallel to the span direction, **the general structural behavior needs to be clarified** firstly. It has to be paid especially attention to different thermal elongations of the beams and the sandwich panels

## 4 LINE LOADS

4.2 Line loads parallel to the direction of the span, vertical loads, downward (pressing)

### 4.2.1 Special characteristics

There are basically **two possibilities** of the structural behavior

#### 1. Integrated structural behavior (composite unit):

In this case, the additional continuous beams are rigidly connected with the panel, so that a **new integrated system** arises. The structural behavior must be checked experimentally.

Special problems:

- Different stiffness's of the beams and the panel
- Connections between the beams and the panel, since they have to transfer the shear forces due to the composite effect.

## 4 LINE LOADS

4.2 Line loads parallel to the direction of the span, vertical loads, downward (pressing)

### 4.2.1 Special characteristics

#### 2. Additive structural behavior:

In this case no composite effects between the additional continuous beams and the panel should (must) be applied. This can, for example, be achieved by long-holes at the fasteners. **The additional continuous beams only serve for a load distribution in the longitudinal direction.**

## 4 LINE LOADS

4.2 Line loads parallel to the direction of the span, vertical loads, downward (pressing)

### 4.2.2 Tests

For the **integrated structural** behavior **completely new initial type tests** (ITT e.g. according to EN 14509) are necessary for the special composite unit, consisting of the panel and the rigid connected additional continuous beams, to define the relevant design values.

For the **additive structural** behavior **full scale tests** have to be performed. The failure loads of these tests shall **be compared with** the failure loads of the panels without additional continuous beams and with **a uniformly distributed load** (see chapter 5.2.3).

## ECCS TWG 7.9 / CIB W56 12./13.06.2014 Istanbul Panels with Point or Line Loads

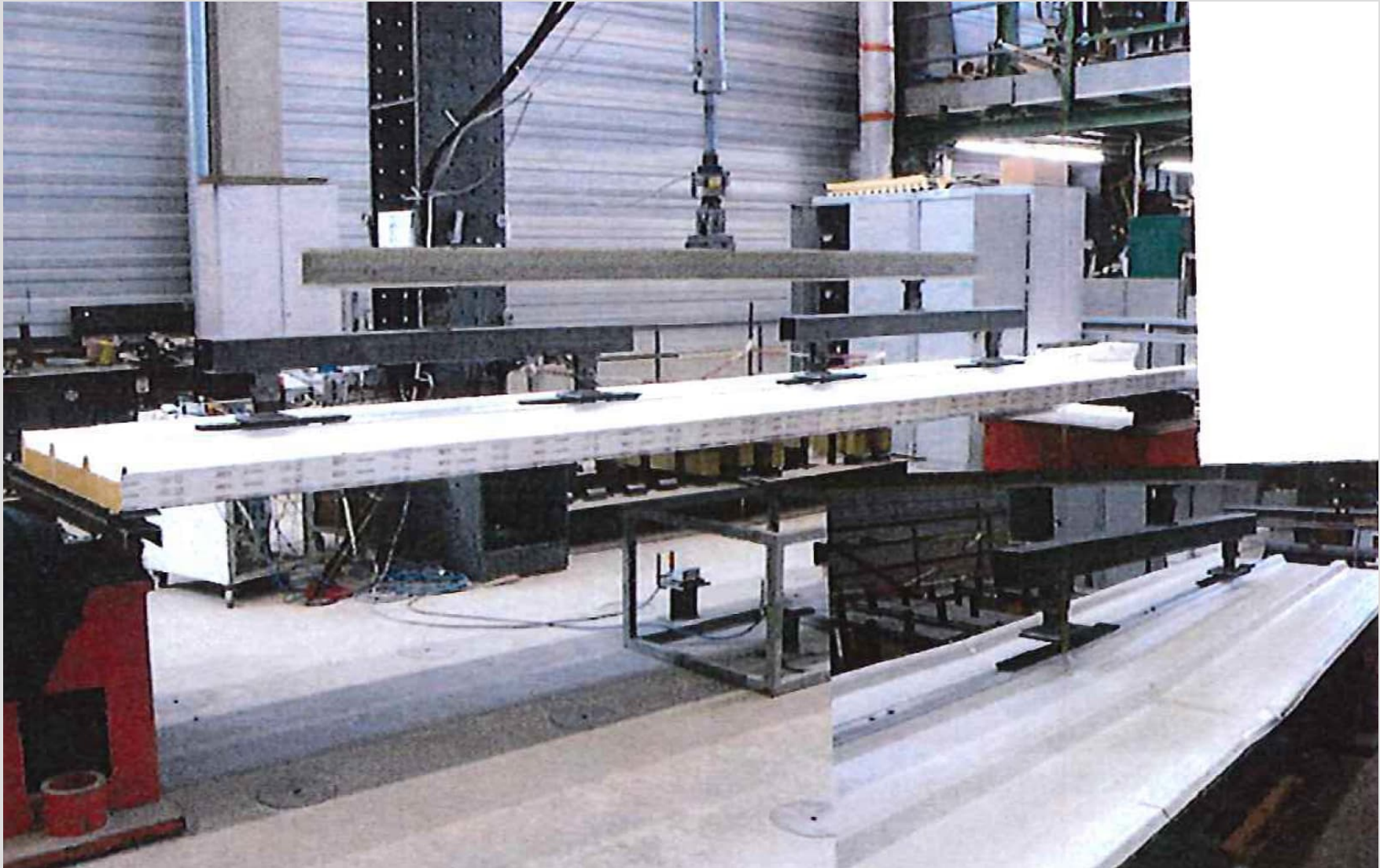

## ECCS TWG 7.9 / CIB W56 12./13.06.2014 Istanbul Panels with Point or Line Loads



## ECCS TWG 7.9 / CIB W56 12./13.06.2014 Istanbul Panels with Point or Line Loads

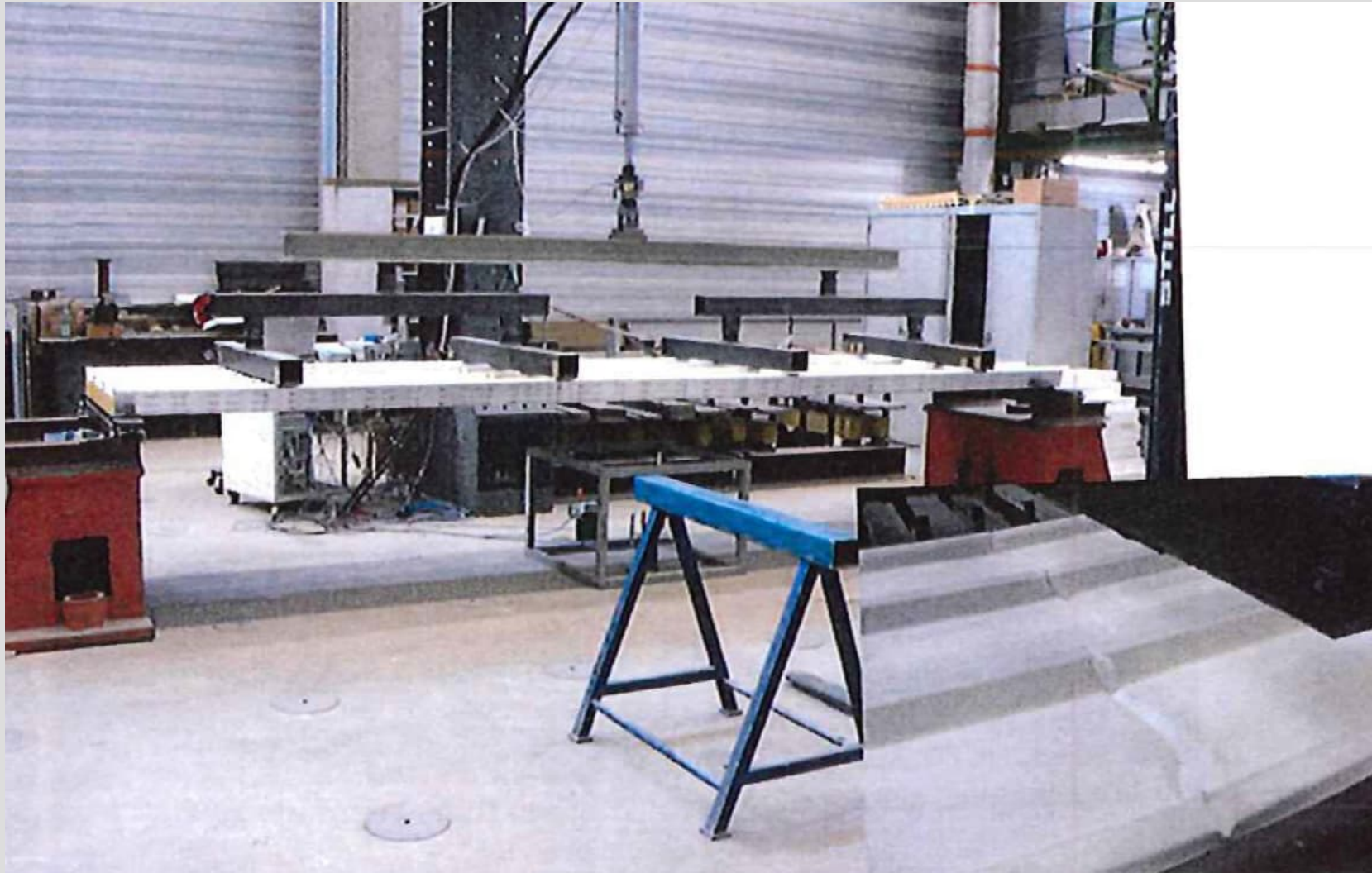



## 4 LINE LOADS

4.2 Line loads parallel to the direction of the span, vertical loads, downward (pressing)

### 4.2.3 Design

For the **integrated structural** behavior the **design must be done** with the design **values defined out of the tests** on the base of a new specified design procedure.

## 4 LINE LOADS

4.2 Line loads parallel to the direction of the span, vertical loads, downward (pressing)

### 4.2.3 Design

For the **additive behavior**, there are three approaches:

- a) For the practical application **all tests shall be performed** analogous to the ITT tests according to EN 14509 with line loads and **the relevant design values shall be defined**.
  
- b) **But a good way is also to define load bearing width**. This can be done if the achieved failure loads for linear loads are compared with the achieved failure loads for uniformly distributed load. If the load bearing width should be directly determined, it has to be ensured that all possible failure modes, static systems and panel dimensions must be checked.

## 4 LINE LOADS

4.2 Line loads parallel to the direction of the span, vertical loads, downward (pressing)

### 4.2.3 Design

For the **additive behavior**, there are three approaches:

- c) To reduce the number of tests, there is also a simplified procedure possible, only with **confirmation tests**. There will be carried out confirmation tests only due of the fact that for concrete-filled trapezoidal sheets as there are **already defined loadbearing widths** given in the **German DASTb directive 240** for linear loads

## Panels with Point or Line Loads

### 4 LINE LOADS

4.2 Line loads parallel to the direction of the span, vertical loads, downward (pressing)

#### 4.2.3 Design

	1	2	3			4
	Stat. System Schnittgröße	Mitwirkende Breite (rechner. Lastverteilungs- breite) $b_m$	Gültigkeitsgrenzen			Mitwirkende Breite $b_m$ , gültig für durchgehende Linienlast ( $t_x=l$ ) $t_y=0,05l$   $t_y=0,1l$
1		$b_m = t_y + 2,5 \cdot x \left(1 - \frac{x}{l}\right)$	$0 < x < l$	$t_y \leq 0,8l$	$t_x \leq l$	$b_m = 1,36l$
2		$b_m = t_y + 0,5 \cdot x$	$0 < x < l$	$t_y \leq 0,8l$	$t_x \leq l$	$b_m = 0,25l$   $b_m = 0,30l$
3		$b_m = t_y + 1,5 \cdot x \left(1 - \frac{x}{l}\right)$	$0 < x < l$	$t_y \leq 0,8l$	$t_x \leq l$	$b_m = 1,01l$
4		$b_m = t_y + 0,5 \cdot x \left(2 - \frac{x}{l}\right)$	$0 < x < l$	$t_y \leq 0,8l$	$t_x \leq l$	$b_m = 0,67l$
5		$b_m = t_y + 0,3 \cdot x$	$0,2l < x < l$	$t_y \leq 0,4l$	$t_x \leq 0,2l$	$b_m = 0,25l$   $b_m = 0,30l$
6		$b_m = t_y + 0,4 \cdot (l - x)$	$0 < x < 0,8l$	$t_y \leq 0,4l$	$t_x \leq 0,2l$	$b_m = 0,17l$   $b_m = 0,21l$
7		$b_m = t_y + x \left(1 - \frac{x}{l}\right)$	$0 < x < l$	$t_y \leq 0,8l$	$t_x \leq l$	$b_m = 0,86l$
8		$b_m = t_y + 0,5 \cdot x \left(2 - \frac{x}{l}\right)$	$0 < x < l$	$t_y \leq 0,4l$	$t_x \leq l$	$b_m = 0,52l$
9		$b_m = t_y + 0,3 \cdot x$	$0,2l < x < l$	$t_y \leq 0,4l$	$t_x \leq 0,2l$	$b_m = 0,21l$   $b_m = 0,25l$
10		$b_m = 2l_k + 1,5 \cdot x$ $b_m = t_y + 1,5 \cdot x$	$0 < x < l_k$ $0 < x < l_k$	$t_y < 0,2l_k$ $0,2l_k \leq t_y$ $\leq 0,8l_k$	$t_x \leq l_k$ $t_x \leq l_k$	$b_m = 1,35l_k$
11		$b_m = 0,2l_k + 0,3 \cdot x$ $b_m = t_y + 0,3 \cdot x$	$0,2l_k < x < l_k$ $0,2l_k < x < l_k$	$t_y < 0,2l_k$ $0,2l_k \leq t_y$ $\leq 0,4l_k$	$t_x \leq 0,2l_k$ $t_x \leq 0,2l_k$	$b_m = 0,36l_k$   $b_m = 0,43l_k$

Allgemeine bauaufsichtliche Zulassung  
Nr. Z-10.4-540 vom 22. Mai 2012



Mitwirkende Breiten (rechnerische Lastverteilungsbreiten)  
Quer zur Spannrichtung bei Linien- und Einzellasten

1	Einzellasten		Linienlasten
	2	3	4
Statisches System Schnittgrößen	Mitwirkende Breite $b_w$	Gültigkeits- grenze	Mitwirkende Breite $b_w$
<b>Einfeldträger</b>			
a B-Moment 	$b_w = 40 \text{ mm} + 2 \cdot x \cdot (1 - x/l)$	$0 \leq x \leq l/2$	$b_w = 1,31 \cdot l$
b Querkraftaufbau 	$b_w = 40 \text{ mm} + 0,5 \cdot x$		$b_w = 0,2 \cdot l$
<b>Endfelder von Durchlaufträgern</b>			
c Freiendmoment 	$b_w = 40 \text{ mm} + 1,33 \cdot x \cdot (1 - x/l)$	$0 \leq x \leq l$	$b_w = 0,96 \cdot l$
d Stützmoment 	$b_w = 40 \text{ mm} + 0,45 \cdot x \cdot (2 - x/l)$		$b_w = 0,62 \cdot l$
e Querkraftaufbau 	$b_w = 40 \text{ mm} + 0,3 \cdot x$	$0,2 \cdot l \leq x \leq l$	$b_w = 0,2 \cdot l$
f Überkraftaufbau 	$b_w = 40 \text{ mm} + 0,4 \cdot l \cdot (1 - x/l)$	$0 \leq x \leq 0,8 \cdot l$	$b_w = 0,15 \cdot l$

Die Mitwirkende Breite ist symmetrisch zum Lastschwerpunkt anzusetzen, sie darf nicht größer als die vorhandene Baubreite des Sandwichelements sein.

$x$  = Achsabstand der Einzellast (Soglast) vom Auflager

Tragende Sandwichelemente "FischerTHERM" und "FischerFIREPROOF"  
Wand- und Dachelemente

Mittragende Breite bei Linien- und Einzellasten



# ECCS TWG 7.9 / CIB W56 12./13.06.2014 Istanbul

## Panels with Point or Line Loads

Allgemeine bauaufsichtliche Zulassung  
Nr. Z-10.4-540 vom 22. Mai 2012

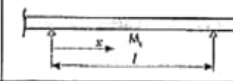
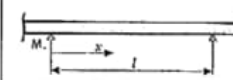
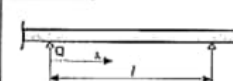
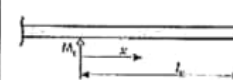
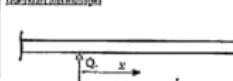

Mitwirkende Breiten (rechnerische Lastverteilungsbreiten)  
Quer zur Spannrichtung bei Linien- und Einzellasten

1	Einzellasten		Linienlasten
	2	3	4
Statisches System Schnittgrößen	Mitwirkende Breite $b_w$	Gültigkeits- grenze	Mitwirkende Breite $b_w$
<b>Innenfelder von Durchlaufträgern</b>			
g Feldmoment 	$b_w = 40 \text{ mm} + 0,8 \cdot x \cdot (1 - x/l)$	$0 \leq x \leq l/2$	$b_w = 0,81 \cdot l$
h Stützmoment 	$b_w = 40 \text{ mm} + 0,45 \cdot x \cdot (2 - x/l)$	$0 \leq x \leq l/2$	$b_w = 0,47 \cdot l$
i Querkraftausfallger 	$b_w = 40 \text{ mm} + 0,3 \cdot x$	$0,2 \cdot l < x < l/2$	$b_w = 0,18 \cdot l$
<b>Kragträger</b>			
j Stützmoment 	$b_w = 40 \text{ mm} + 1,33 \cdot x$	$0 \leq x \leq l_k$	$b_w = 1,3 \cdot l_k$
k Querkraftausfallger 	$b_w = 40 \text{ mm} + 0,3 \cdot x$	$0,2 \cdot l_k \leq x \leq l_k$	$b_w = 0,31 \cdot l_k$

Die Mitwirkende Breite ist symmetrisch zum Lastschwerpunkt anzusetzen, sie darf nicht größer als die vorhandene Baubreite des Sandwichelements sein.  
 $x$  = Achsabstand der Einzellast (Soglast) vom Auflager



Tragende Sandwichelemente "FischerTHERM" und "FischerFIREPROOF"  
Wand- und Dachelemente

Mittragende Breite bei Linien- bzw. Einzellasten

Anlage B, Blatt 3.03.2

## 4 LINE LOADS

4.2 Line loads parallel to the direction of the span, vertical loads, downward (pressing)

### 4.2.3 Design

For the additive behavior, the approach c):

Tests with e.g. simply supported panels can be carried out and the results can be compared e.g. on calculated stresses with full and with loadbearing widths.

$\sigma_w ; f_{Cv}$  : wrinkling stress, shear strength with uniformly distributed load

$\sigma_{w,L} ; f_{Cv,L}$  : wrinkling stress, shear strength with line load (test result)

$b$ : full panel width

$b_w$ : load bearing width

$$\begin{aligned} \text{If } \sigma_{w,L} ; f_{Cv,L} &\geq \sigma_w ; f_{Cv} &\rightarrow & b_w = b \\ \text{If } \sigma_{w,L} ; f_{Cv,L} &< \sigma_w ; f_{Cv} &\rightarrow & b_w = \frac{\sigma_{w,L}}{\sigma_w} b ; b_w = \frac{f_{Cv,L}}{f_{Cv}} b \end{aligned}$$

## 4 LINE LOADS

4.1 Line loads transversely to the direction of the span, vertical loads, downward (pressing)

### 4.2.3 Design

With the results from the tests or the defined load bearing widths analogous to the trapezoidal sheets, the stresses of the line loads can be calculated directly on the base of chapter E of EN 14509 (see sketch).

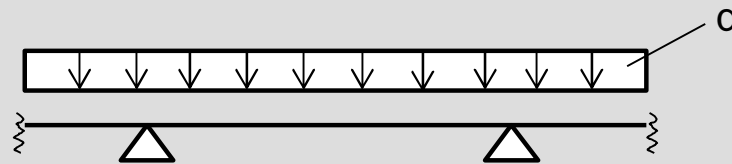

$q$	=	design load = $q_L * \frac{b}{b_w}$
$q_L$	=	line load
$b$	=	full panel width
$b_w$	=	load bearing width



## 5 POINT LOADS

5.1 Point loads, vertical loads, downwards (pressing)

5.1.1 Special characteristics

If the loading of sandwich panels are point loads due to vertical loads without distribution beams it has to be assumed, that **the position of the point loads can be at any place both in the transverse direction and in the longitudinal direction.**

## 5 POINT LOADS

5.1 Point loads, vertical loads, downwards (pressing)

### 5.1.1 Special characteristics

For **load distribution beams** transversely to span direction, which are **not provided over the full width** of the panel the stresses shall be calculated **also with point loads**. Short beams and eccentric loads (load groups) may require additional considerations.

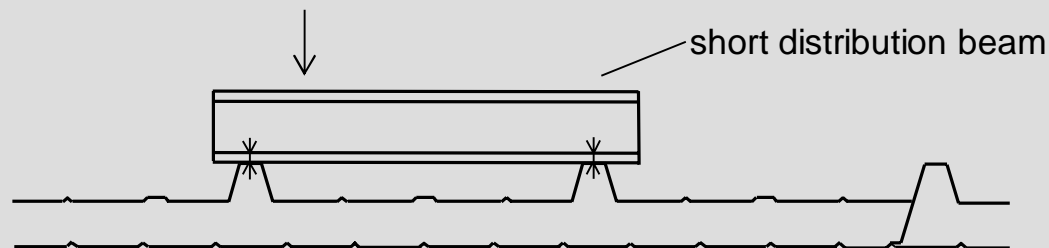

## 5 POINT LOADS

### 5.1 Point loads, vertical loads, downwards (pressing)

#### 5.1.2 Tests

To cover all possible effects due to point loads under all possible load positions only per testing (design by testing), a very large number of tests would be required. It would need tests for each panel type, all static systems with all load positions.

For more-span-panels the experimental effort would be even higher, since various relevant load position combinations have to be tested.

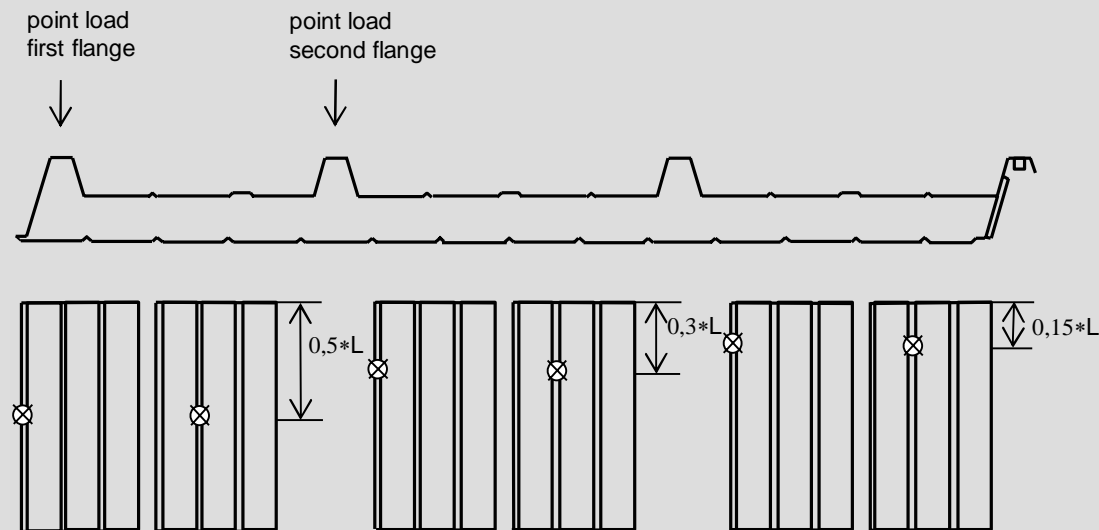

## 5 POINT LOADS

5.1 Point loads, vertical loads, downwards (pressing)

### 5.1.2 Tests

But with these test results it would be possible then to define load-bearing widths, respectively by comparison with the test results (failure loads), obtained by tests with uniformly distributed load.

To reduce the number of tests but still ensure an accurate design the following simplified procedure is proposed

# ECCS TWG 7.9 / CIB W56 12./13.06.2014 Istanbul

## Panels with Point or Line Loads

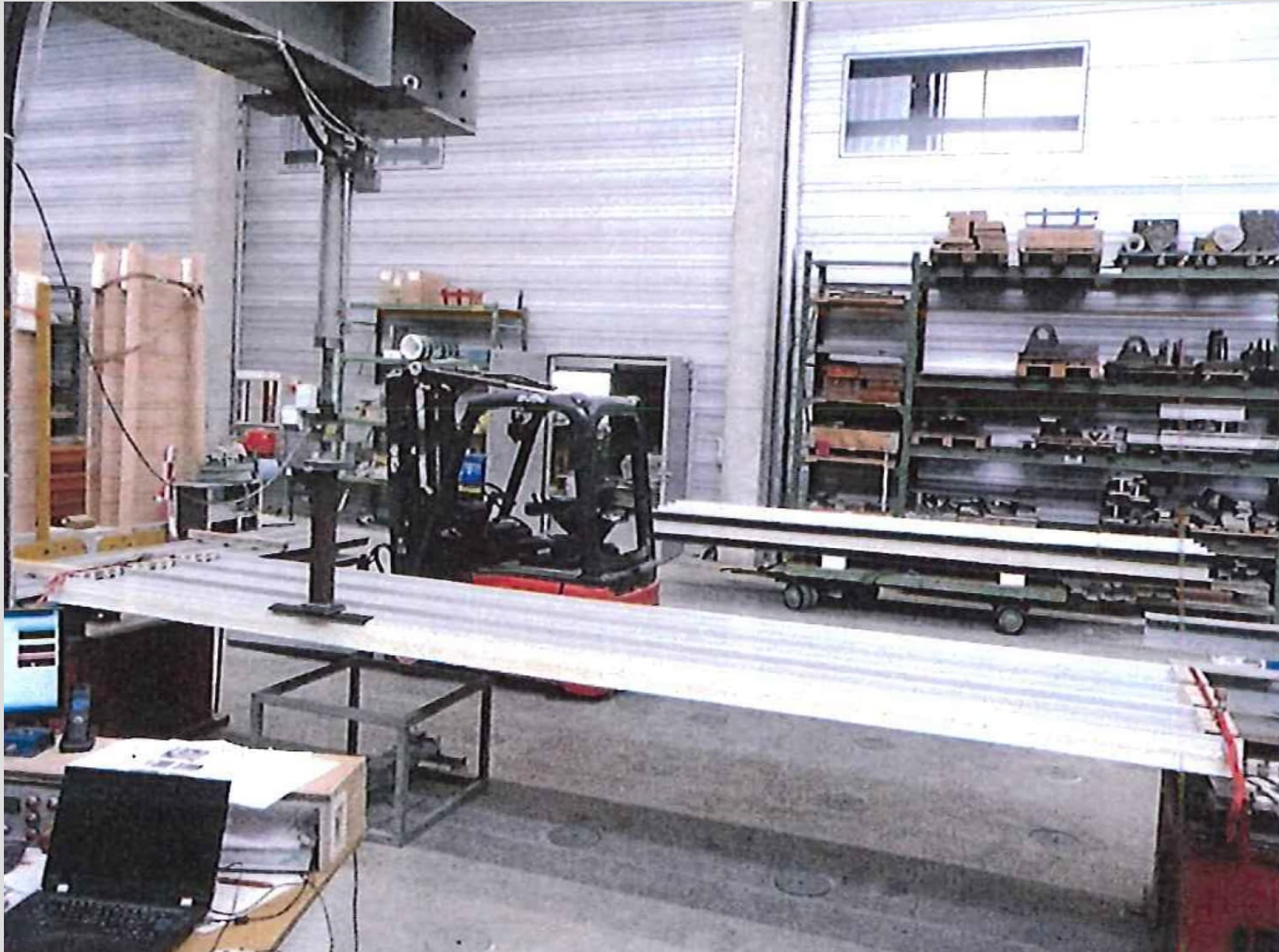

## ECCS TWG 7.9 / CIB W56 12./13.06.2014 Istanbul Panels with Point or Line Loads

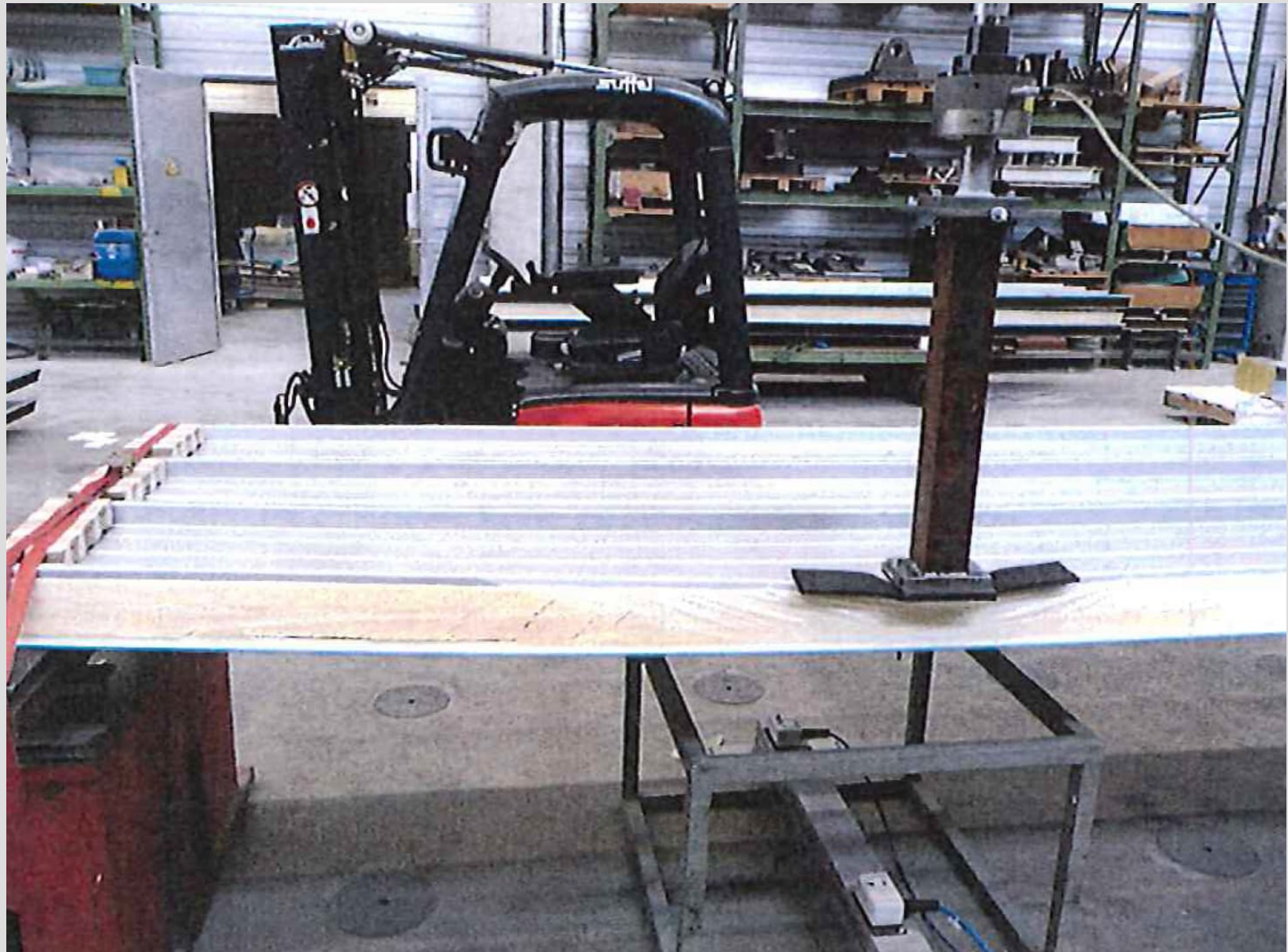

## 5 POINT LOADS

### 5.1 Point loads, vertical loads, downwards (pressing)

#### 5.1.3 Design

Only confirmation tests must be done, as there are already for concrete-filled trapezoidal sheets defined load bearing widths given in DIN 18807, Part 3, Table 2 for point loads (see Annex II). If these widths are accepted tests can be targeted, for example for one span panels in above-mentioned way and the results, e.g. the calculations of the stresses, can be compared to stresses with the results for full width (see chapter 2.2.3).

If the values for the load bearing width defined with the tests are greater than or equal to, it can be assumed that also other load bearing widths of the list can be used also for other systems, e.g. for multi span panels.

# ECCS TWG 7.9 / CIB W56 12./13.06.2014 Istanbul

## Panels with Point or Line Loads

### 5 POINT LOADS

#### 5.1 Point loads, vertical loads, downwards (pressing)

#### 5.1.3 Design

Lfd. Nr	1 Statisches System Schnittgrößen	2 Rechnerische Lastverteilungsbreite $b_w$	3 Gültigkeitsgrenzen
1		$b_w = b_e + 2 \cdot x \cdot \left(1 - \frac{x}{l}\right)$	$0 < x < l/2$ $b_e < 0,8 \cdot l$
2		$b'_w = b_e + 0,5 \cdot x$	
3		$b_w = b_e + 1,33 \cdot x \cdot \left(1 - \frac{x}{l}\right)$	$0 < x < l$ $b_e < 0,8 \cdot l$
4		$b_w = b_e + 0,45 \cdot x \cdot \left(2 - \frac{x}{l}\right)$	
5		$b'_w = b_e + 0,3 \cdot x$	$0,2 \cdot l < x < l$
6		$b'_w = b_e + 0,4 \cdot l \cdot \left(1 - \frac{x}{l}\right)$	$0 < x < 0,8 \cdot l$ $b_e \leq 0,4 \cdot l$
7		$b_w = b_e + 0,8 \cdot x \cdot \left(1 - \frac{x}{l}\right)$	$0 < x < l/2$ $b_e < 0,8 \cdot l$
8		$b_w = b_e + 0,45 \cdot x \cdot \left(2 - \frac{x}{l}\right)$	$0 < x < l/2$ $b_e < 0,4 \cdot l$
9		$b'_w = b_e + 0,3 \cdot x$	$0,2 \cdot l < x < l/2$ $b_e < 0,4 \cdot l$
10		$b_w = b_e + 1,33 \cdot x$	$0 < x < l_k$ $b_e \leq 0,8 \cdot l_k$
11		$b'_w = b_e + 0,3 \cdot x$	$0,2 \cdot l_k < x < l_k$ $b_e \leq 0,4 \cdot l_k$



## 5 POINT LOADS

### 5.1 Point loads, vertical loads, downwards (pressing)

#### 5.1.3 Design

With the defined load bearing widths the stresses of the point loads can be calculated directly on the base of chapter E of EN 14509 (see sketch). For a practical design the stresses have to be combined with the stresses of other load cases. The design procedure of EN 14509 can be applied directly.

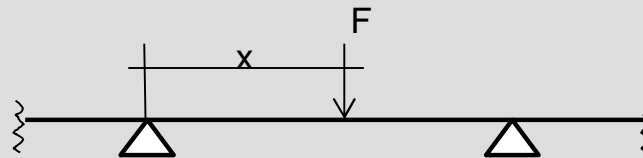

$F$	=	design load = $F_p * \frac{b}{b_w}$
$F_p$	=	point load
$b_w$	=	relevant load bearing width, depending on the load position
$x$	=	distance to the support

## 5 POINT LOADS

### 5.2 Point-loads, vertical loads, upward (uplifting)

#### 5.2.1 Special tasks

Regarding the stresses of sandwich panels due to **uplifting point loads** (e.g. by wind suction) it can be assumed that the structural behavior of sandwich panels can be determined in the **same manner as point loads due to pressing loads** because the load bearing widths are in principle independent of the load direction. Thus, the **design** of the panels can be done also **in the same way** as in chapter 5.1.3

## 5 POINT LOADS

### 5.2 Point-loads, vertical loads, upward (uplifting)

#### 5.2.1 Special tasks

In addition to the special procedure for the design of the panels with point loads, however, still two more issues must be considered:

- a) Characteristic values for each of the special types of fixing are required for the **definition of pull out values of the fixings from the upper face**, which must be determined by **tests** especially to capture the local effects.

For the procedure of the pull out tests and the evaluation specific **ECCS Recommendations shall be used**.

## ECCS TWG 7.9 / CIB W56 12./13.06.2014 Istanbul Panels with Point or Line Loads

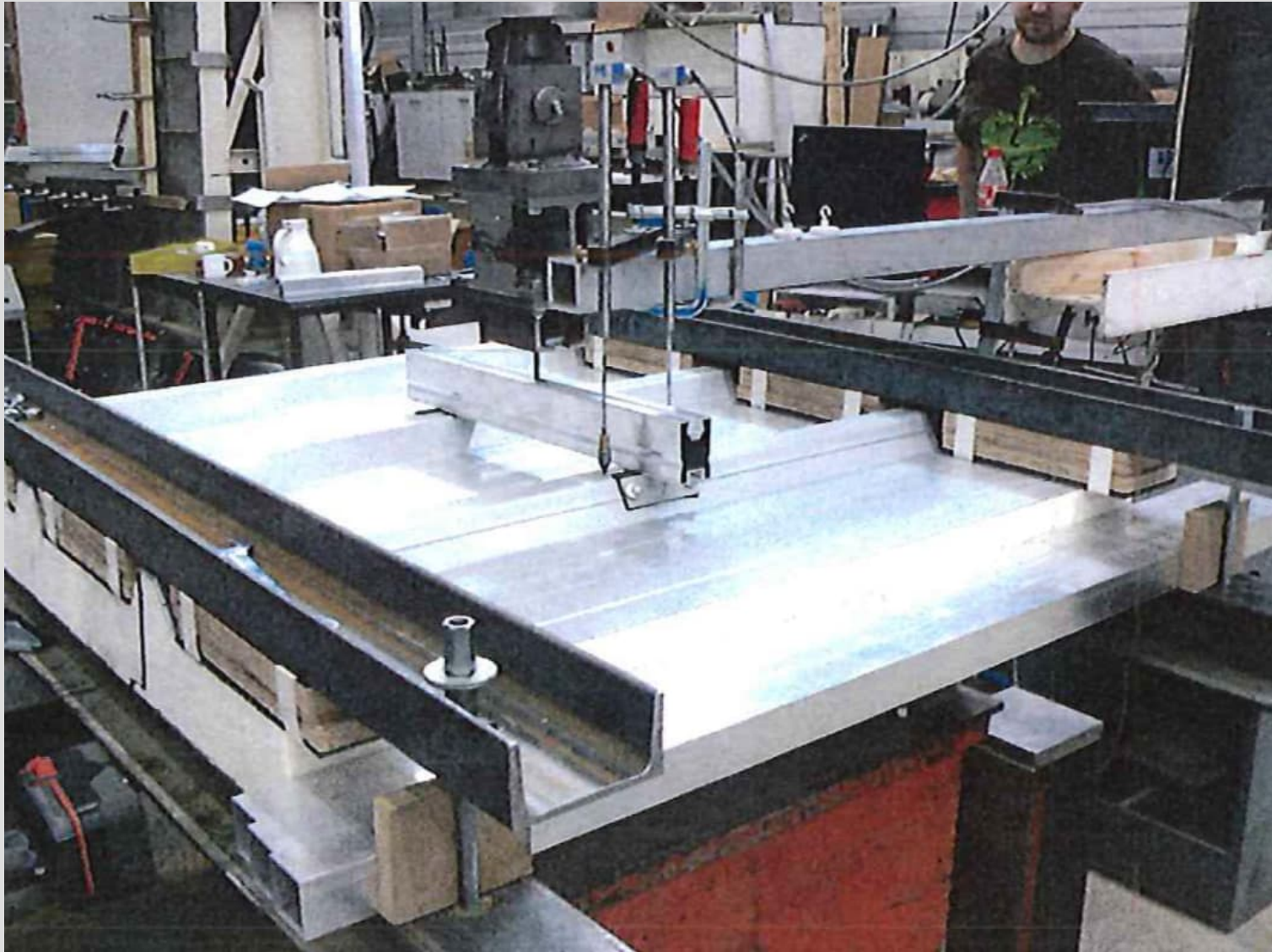

## ECCS TWG 7.9 / CIB W56 12./13.06.2014 Istanbul Panels with Point or Line Loads

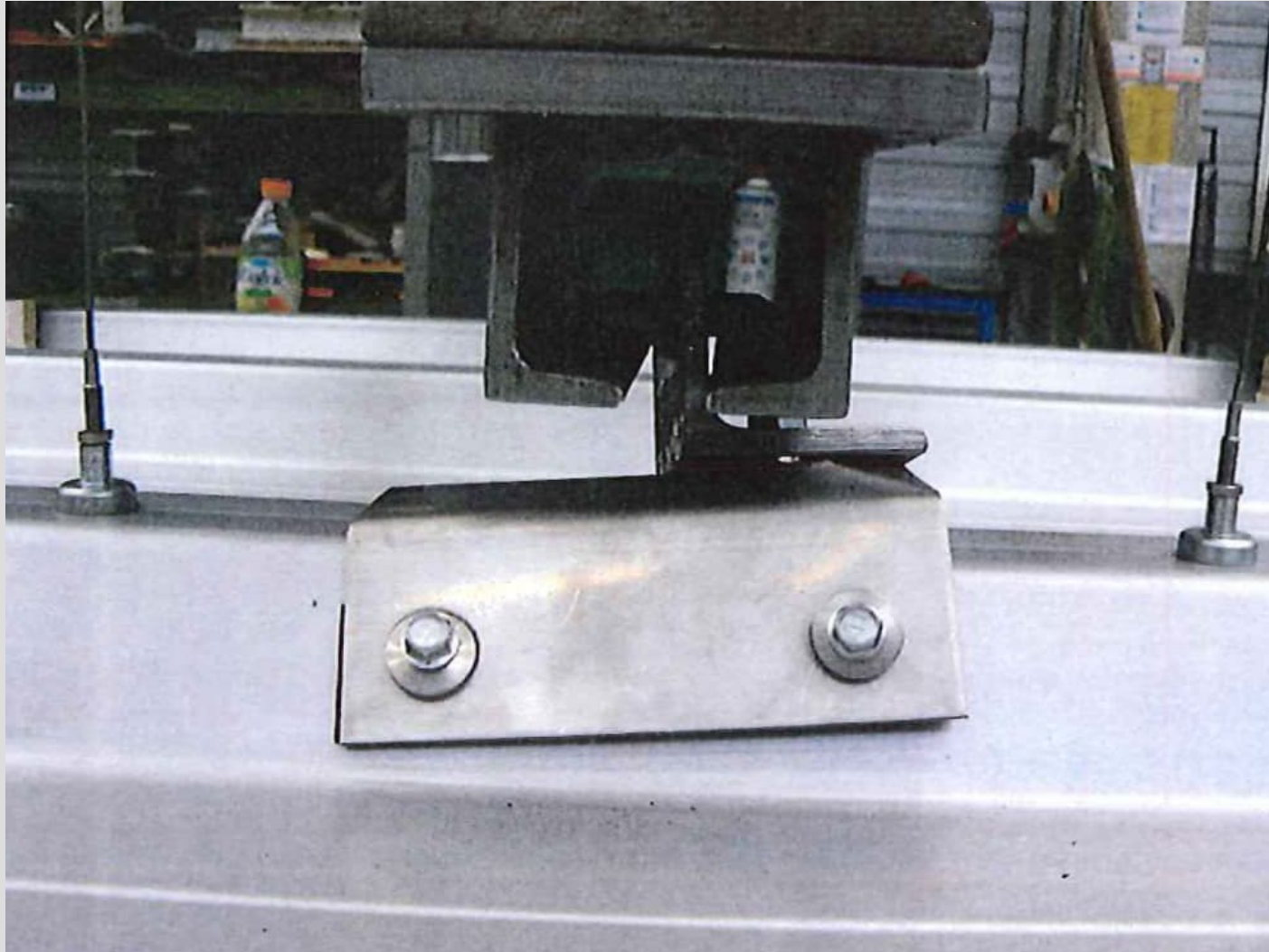

# ECCS TWG 7.9 / CIB W56 12./13.06.2014 Istanbul Panels with Point or Line Loads



## 5 POINT LOADS

### 5.2 Point-loads, vertical loads, upward (uplifting)

#### 5.2.1 Special tasks

- b) In cases where the above mentioned characteristic values are used for the design, **is not excluded that in the upper face in the area of the fixings local defects or damages**, such as delamination of the faces from the core, bubbles or holes due of pull out of the screws etc. occur when reaching the failure loads of the fixings. These local damages in the face can have an **influence on the structural behavior of the panels**, because in the area of the damages **early buckling or wrinkling can arise** and thus expected to lower failure loads of the panels. To check the structural behavior with eventually local damages in the upper face there are **special tests required** (see 5.2.2).

## 5 POINT LOADS

### 5.2 Point-loads, vertical loads, upward (uplifting)

#### 5.2.2 Tests

For checking the **structural behavior of panels with local damages** in the area of the fixings the following tests are recommended:

- **Full scale tests** with panels and **undisturbed faces**: Determining the failure loads.
- **Full scale tests** with panels and faces **with local damages** due to pull out of the fixings: The damages of the outer face may be provided realistically before the full scale test by **pulling out of the fixings** directly on the panel analogous to the test conditions for the determination of the pull out values after dynamic preload until failure of the fixing.
- **By comparing** the failure loads of the panel tests, **with and without local damages** the influence of the defect can be detected and the **reduction of the load capacity** of the panels with fixings on the outer face **can be defined** for the practical design.



## ECCS TWG 7.9 / CIB W56 12./13.06.2014 Istanbul Panels with Point or Line Loads



## ECCS TWG 7.9 / CIB W56 12./13.06.2014 Istanbul Panels with Point or Line Loads



# ECCS TWG 7.9 / CIB W56 12./13.06.2014 Istanbul

## Panels with Point or Line Loads

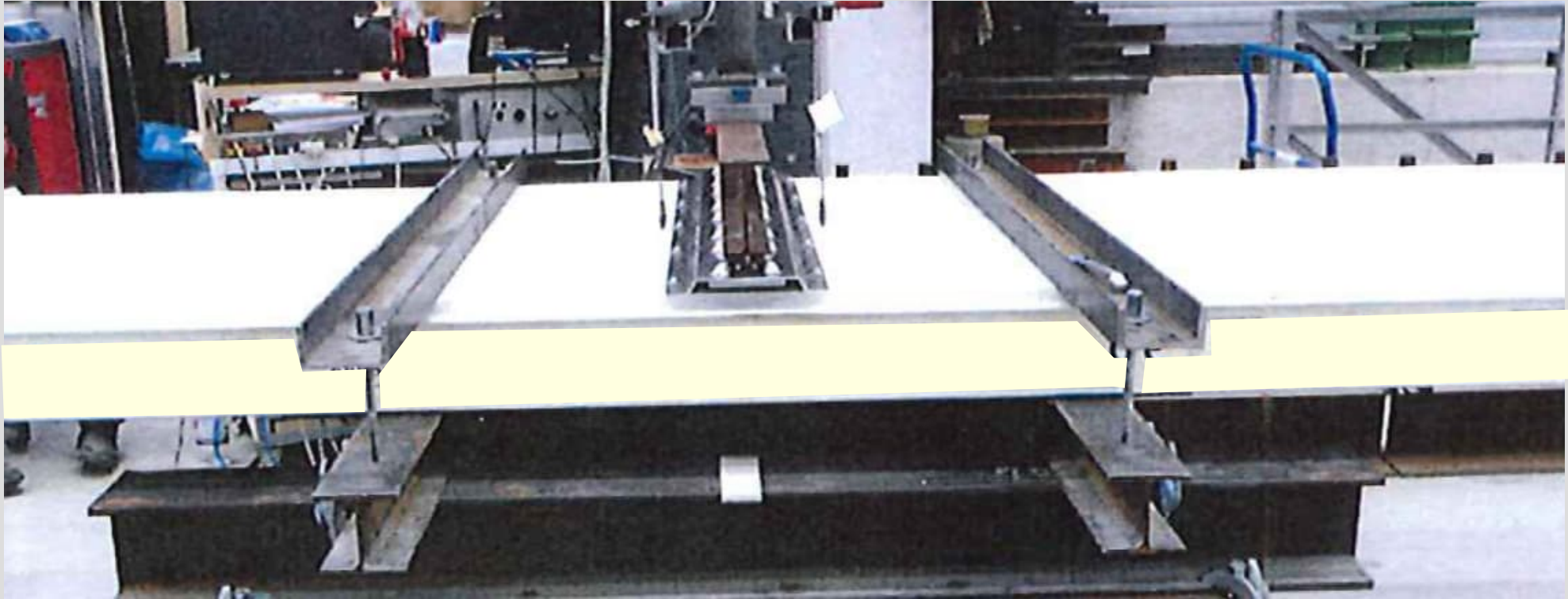

## ECCS TWG 7.9 / CIB W56 12./13.06.2014 Istanbul Panels with Point or Line Loads

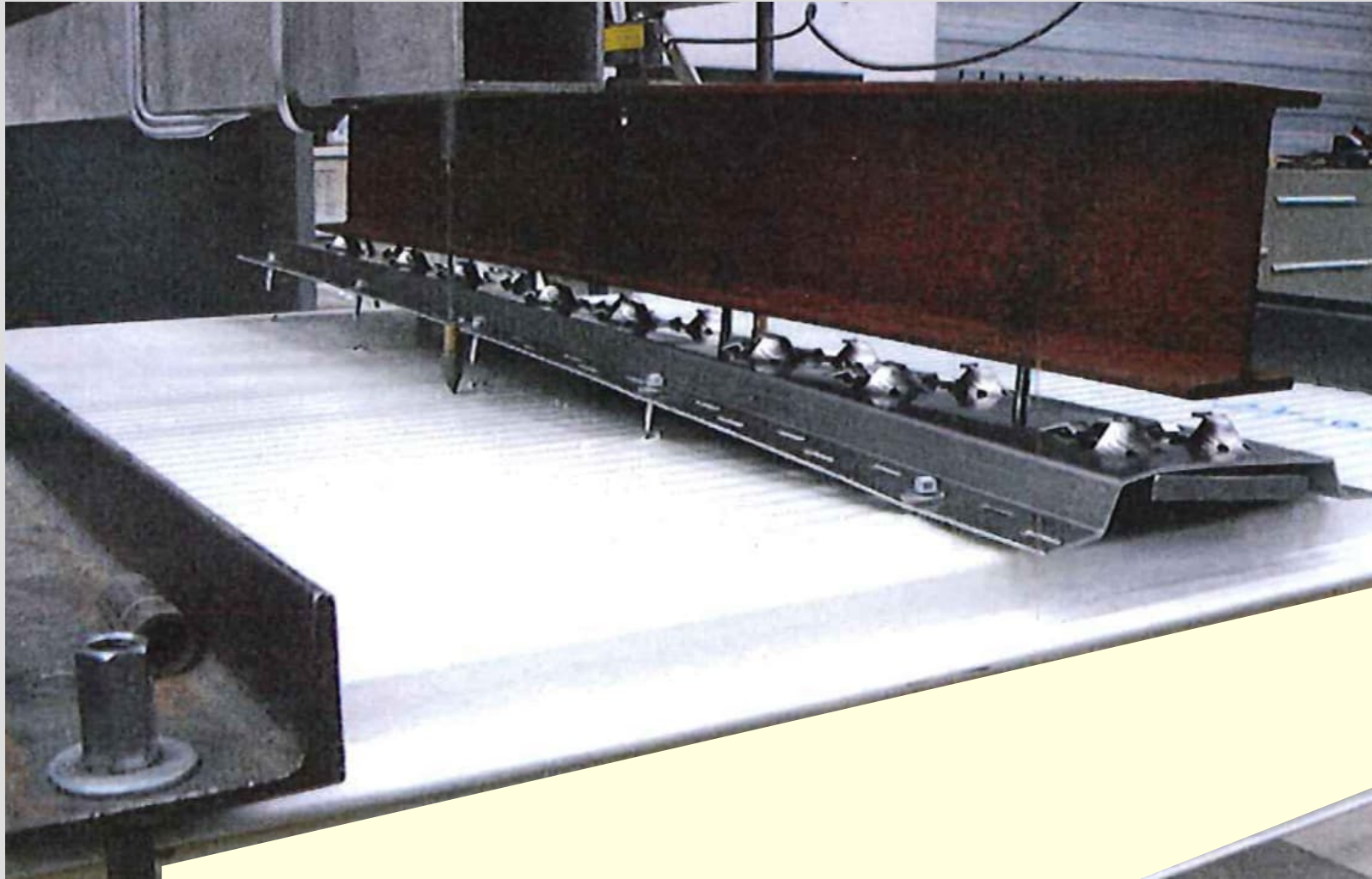

# ECCS TWG 7.9 / CIB W56 12./13.06.2014 Istanbul Panels with Point or Line Loads



## ECCS TWG 7.9 / CIB W56 12./13.06.2014 Istanbul Panels with Point or Line Loads



## 5 POINT LOADS

5.2 Point-loads, vertical loads, upward (uplifting)

### 5.2.2 Tests

Tests to determine the load bearing widths for uplifting point loads are not necessary, since the corresponding values can be taken over from the tests of pressing point loads

# ECCS TWG 7.9 / CIB W56 12./13.06.2014 Istanbul

## Panels with Point or Line Loads

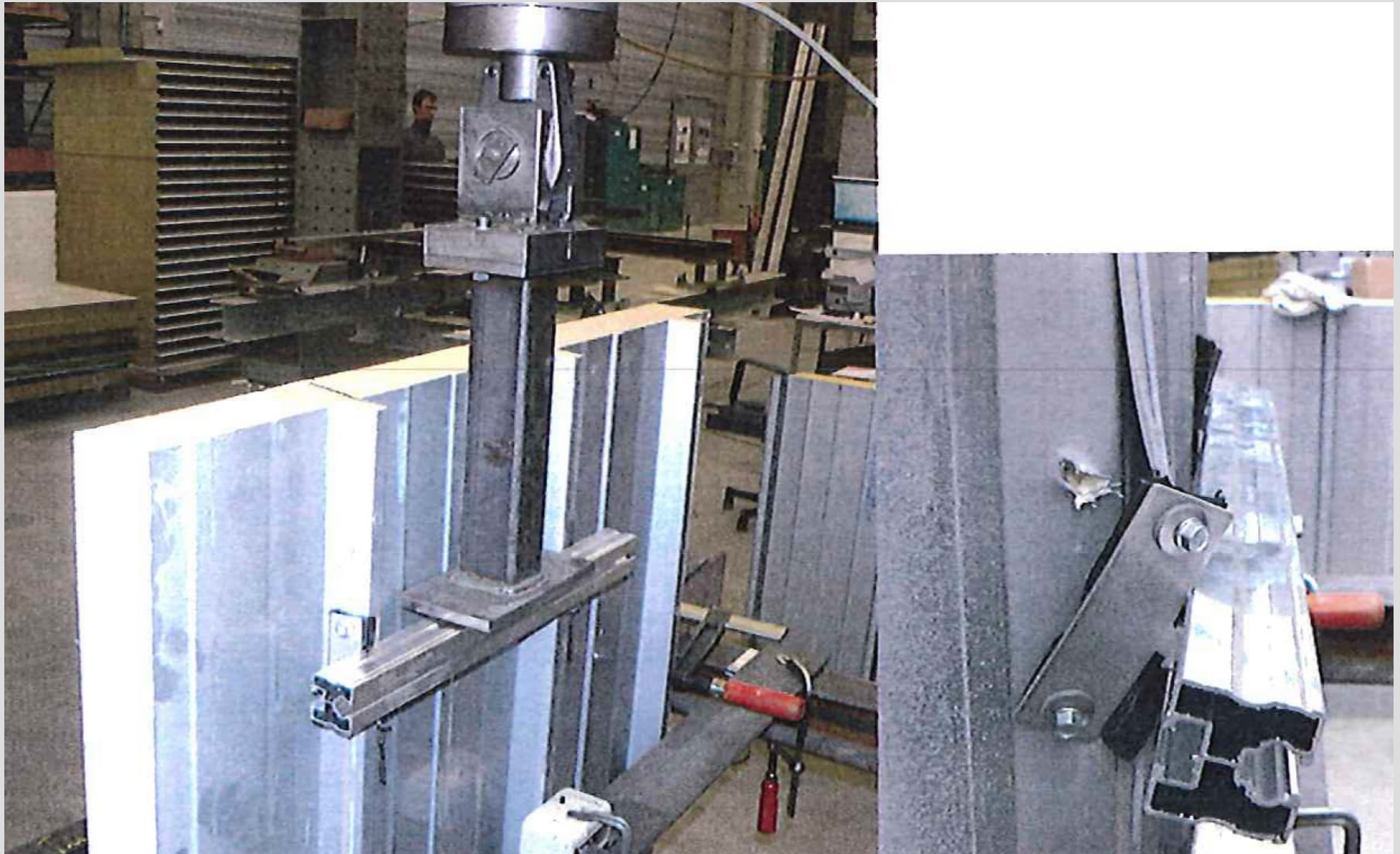



## ECCS TWG 7.9 / CIB W56 12./13.06.2014 Istanbul Panels with Point or Line Loads

